



F A R N A M
CUSTOM PRODUCTS



Standard Control Panel

Operation Manual

24x24x10 Control Panels
36x36x12 Control Panels
1 or 3 Phases
Up to 48 FLA per Circuit

Rev. A
August 2024

Revision Sheet

Release No.	Date	Revision Description	Rev By
Rev. A	08/27/24	Operation Manual Initial Release	Jordi Enriquez

NOTICE

FARNAM RESERVES THE RIGHT TO MAKE CHANGES TO ITS PRODUCTS OR SPECIFICATIONS AT ANY TIME, WITHOUT NOTICE, IN ORDER TO IMPROVE THE DESIGN OR PERFORMANCE AND TO SUPPLY THE BEST POSSIBLE PRODUCT. THE INFORMATION IN THIS MANUAL HAS BEEN CAREFULLY CHECKED AND IS BELIEVED TO BE ACCURATE. HOWEVER, NO RESPONSIBILITY IS ASSUMED FOR INACCURACIES.

LIMITED WARRANTY

WARRANTY: FARNAM WARRANTS ITS NEW PRODUCTS TO BE FREE FROM DEFECTS IN MATERIALS AND WORKMANSHIP UNDER THE SERVICE FOR WHICH THEY ARE INTENDED. THIS WARRANTY IS EFFECTIVE FOR TWELVE MONTHS FROM THE DATE OF SHIPMENT.

EXCLUSIONS: THIS WARRANTY IS IN LIEU OF ANY OTHER WARRANTY EXPRESSED OR IMPLIED, INCLUDING, BUT NOT LIMITED TO ANY IMPLIED WARRANTY OF **MERCHANTABILITY** OR FITNESS FOR A PARTICULAR PURPOSE.

FARNAM IS NOT LIABLE FOR ANY INCIDENTAL OR CONSEQUENTIAL DAMAGES.

NO PERSON OTHER THAN AN OFFICER IS AUTHORIZED TO GIVE ANY OTHER WARRANTY OR ASSUME ANY LIABILITY.

REMEDIES: THE PURCHASER'S SOLE AND EXCLUSIVE REMEDY SHALL BE: (1) THE REPAIR OR REPLACEMENT OF DEFECTIVE PARTS OR PRODUCTS, WITHOUT CHARGE. (2) AT THE OPTION OF FARNAM, THE REFUND OF THE PURCHASE PRICE.



**F A R N A M
CUSTOM PRODUCTS**

**Operation Manual
Authorization Memorandum**

I have carefully assessed the Operation Manual for our Standard Control Panels. This document has been completed thoroughly to describe use of control panels.

MANAGEMENT CERTIFICATION - Please check the appropriate statement.

The document is accepted.

The document is accepted pending the changes noted.

The document is not accepted.

We fully accept the changes as needed improvements and authorize initiation of work to proceed. Based on our authority and judgment, the continued use of this manual is authorized.



NAME
Engineering Manager

8/28/2024

DATE



NAME
UL 508A Manufacturing Technical Representative

8/28/2024

DATE

Notes:

OPERATION MANUAL

TABLE OF CONTENTS

	<u>Page #</u>
A. <u>GENERAL INFORMATION</u>	A-1
1.1 Safety Information	A-1
1.2 Points of Contact	A-2
1.3 Acronyms and Abbreviations	A-2
B. <u>CONTROL PANEL OVERVIEW</u>	B-1
2.1 Panel Configuration	B-1
2.2 Panel Layout	B-2
2.2.1 Interior.....	B-2
2.2.2 Exterior.....	B-3
2.2.3 Panel Tags and Stickers.....	B-4
2.3 Panel Components	B-4
C. <u>INSTALLATION AND HOOK-UP</u>	C-1
3.1 Modifying Panel Enclosure	C-1
3.1.1 Input Power Outlet.....	C-1
3.1.2 Output Power and Sensors Outlet.....	C-2
3.2 Mounting the Panel	C-2
3.3 Connecting Panel	C-2
3.3.1 Load Power Connections.....	C-3
3.3.2 Thermocouple Connections.....	C-3
3.3.3 Flow Switch Connection.....	C-3
3.3.4 Remote Connections.....	C-3
3.3.5 (Optional) Eurotherm 3216 High Limit Controller.....	C-3
D. <u>START-UP AND BASIC OPERATION</u>	D-1
4.1 Process Flow Diagrams	D-1
4.2 Powering Panel	D-3
4.3 Operating Panel	D-3
3.1 Process Controller Buttons.....	D-4
4.3.2 Process Controller Navigation.....	D-5
4.3.3 Panel Buttons & Navigation.....	D-6
Setting High Limit Temperature:.....	D-6
Setting Local/Remote Mode:.....	D-6

E.	<u>EUROTHERM PROCCSS CONTROLLER</u>	E-1
5.1	Process	E-1
5.2	Auto Tuning	E-9
5.3	Setting Common Parameters.....	E-9
5.4	Communications	E-10
5.4.1	Ethernet communication	E-10
	Setting IP Address:	E-10
5.4.2	Collecting Data	E-10
5.4.3	Security	E-11
5.4.4	Links to Tutorials and Downloads	E-11
5.5	Alarms	E-12
5.5.1	Other Alarms	E-15
F.	<u>EUROTHERM HIGH LIMIT CONTROLLER</u>	F-1
6.1	High Limit Controller Interface.....	F-1
6.2	Auto Tuning	F-4
6.3	Alarm Options	F-5
G.	<u>TROUBLESHOOTING</u>	G-1
7.1	Heater not heating up.....	G-1
7.2	Shuts down with the High Limit red light on.....	G-1
7.3	Will not settle on set point.....	G-1
7.4	Error/notification messages on controller.....	G-1
7.5	Panel buttons not working.....	G-1
7.6	Panel controls & display not powering on.....	G-2
7.7	Replacing blown fuses.....	G-2
Z.	<u>Appendix</u>	G-1

A. GENERAL INFORMATION

1.1 Safety Information

Read these instructions carefully and look at the equipment to become familiar with the device before trying to install, operate, service, or maintain it. The following special messages may appear throughout this manual or on the equipment to warn of potential hazards or to call attention to information that clarifies or simplifies a procedure.



The addition of either symbol to a “Danger” or “Warning” safety label indicates that an electrical hazard exists which will result in personal injury if the instructions are not followed.



This is the safety alert symbol. It is used to alert you to potential personal injury hazards. Obey all safety messages that follow this symbol to avoid possible injury or death.

DANGER

DANGER indicates a hazardous situation which, if not avoided, will result in death or serious injury.

WARNING

WARNING indicates a hazardous situation which, if not avoided, could result in death or serious injury.

CAUTION

CAUTION indicates a hazardous situation which, if not avoided, could result in minor or moderate injury.

NOTICE

NOTICE is used to address practices not related to physical injury. The safety alert symbol shall not be used with this signal word.

1.2 Points of Contact

Online: <https://farnam-custom.com/>

Email: info@farnam-custom.com

Phone: +1 (828) 684-3766

Address: Tutco Farnam Custom Products
30 Legend Drive
Arden, NC 28704

1.3 Acronyms and Abbreviations

FLA – Full Load Amperage

GND/GRND – Ground

T/C – Thermocouple

PH – Phase

PID – Proportional Integral Derivative

SSR – Solid State Relay

MCB - Main Circuit Breaker

TB – Terminal Block

NO – Normally Open

NC – Normally Closed

B. CONTROL PANEL OVERVIEW

2.1 Panel Configuration

The standard **24x24x10** control panels are offered in the following voltage and main circuit breaker configurations. (Estimated Weight: **80 lbs.**)

Single Phase, 15-60Amp

Available in Voltages VAC 50/60Hz: 120, 200, 208, 240, 277, 380, 400, 415, 460, 480, 575, 600

MCB(FLA): 15(12), 20(16), 30(24), 40(32), 50(40), 60(48)

Three Phase, 15-60Amp

Available in Voltages VAC 50/60Hz: 200, 208, 240, 380, 400, 415, 460, 480, 575W, 575D, 600W, 600D

MCB(FLA): 15(12), 20(16), 30(24), 40(32), 50(40), 60(48)

The standard **36x36x12** control panels are offered in the following voltage and main circuit breaker configurations. (Estimated Weight: **100 lbs.**)

Single Phase, 80-125Amp

Available in Voltages VAC 50/60Hz: 120, 200, 208, 240, 277, 380, 400, 415, 460, 480, 575, 600

MCB(FLA): 80(64), 100(80), 125(96)

Three Phase, 80-125Amp

Available in Voltages VAC 50/60Hz: 200, 208, 240, 380, 400, 415, 460, 480, 575W, 575D, 600W, 600D

MCB(FLA): 80(64), 100(80), 125(96),

2.2 Panel Layout

PANEL LAYOUTS DISPLAY STANDARD PANEL WITH NO OPTIONS OR MODIFICATIONS. LAYOUTS AND COMPONENTS ARE SUBJECT TO CHANGE AND ARE NOT TO SCALE.

2.2.1 Interior

All standard panels will have a similar interior layout with main circuit breaker in top right, over-temperature controller and local/remote switch on mid left and user terminal inputs on bottom left locations.

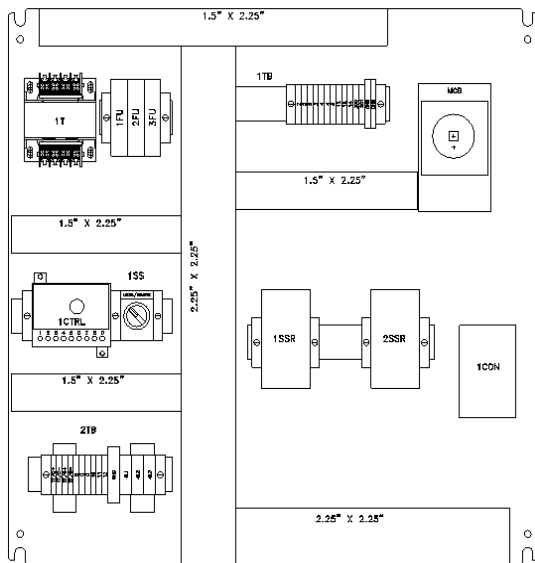

24x24x10 3-Ph Panel Interior

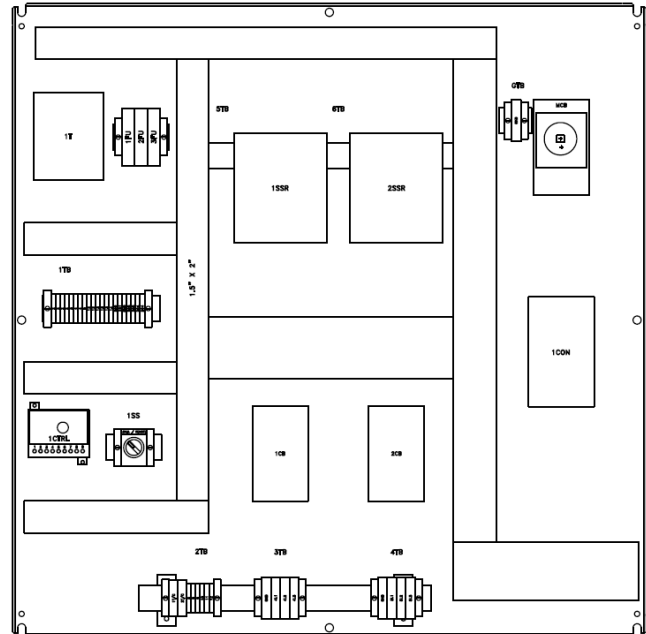

36x36x12 3-Ph Panel Interior

2.2.2 Exterior

All standard panels will have a 3-button layout, with a ‘twist to release’ emergency-stop button and a locking main breaker handle. A Eurotherm process controller will also be on the front of the panel. The left side of the panel includes a RJ45 Ethernet connector to externally program the process controller. The panel door is secured by two ¼ turn latches.

Note: Breaker handle must be in off position, or it will prevent door from opening.

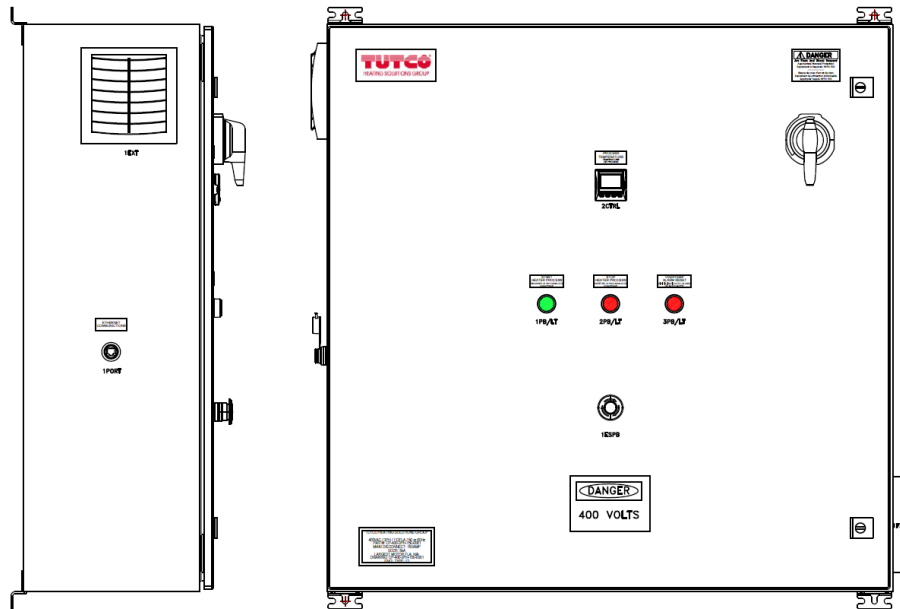

36x36x12 Panel Exterior

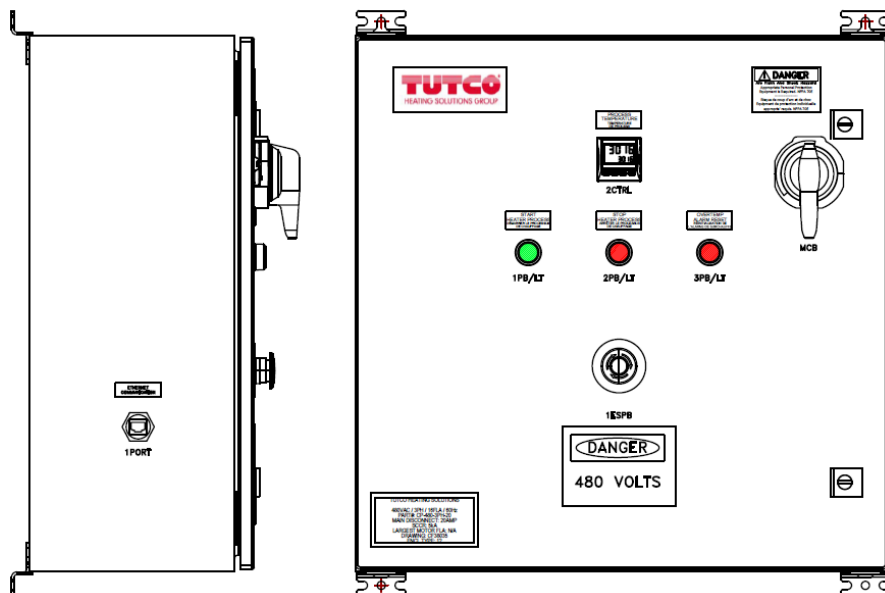

24x24x10 Panel Exterior

2.2.3 Panel Tags and Stickers

Panel will have several tags and stickers that provide information on the panel specifications, certain component info, and certifications.

Fuse Rating tag will show the amp rating each fuse in each location needs to be replaced with. Please use fuses that are same size and classification.

Torque Termination guide has tightening torque values of each component for customer hookup.

Customer Input tag shows wire gauge information and location for wiring remote buttons, switches/sensors, and T/C's.

Heater Control Panel Tag will show max heater load, UL file number, SKP, and build date.

Tutco Heating Solutions tag will show, Volt, Phase, FLA and Hz of panel; part number of panel, main disconnect, SCCR rating, Drawing number, Enclosure Type rating, and largest motor FLA.

Other tags and stickers include button, port, and display labels, safety, and panel arc flash/ voltage stickers.

2.3 Panel Components

Panel components may vary by specification, refer to 'AS-BUILT' drawing shipped with panel for complete component list.

C. INSTALLATION AND HOOK-UP

Disclaimer: ALL WIRING DENOTED AS FIELD WIRING TO BE SUPPLIED BY OTHERS AND INSTALLED BY A QUALIFIED ELECTRICAL CONTRACTOR PER LOCAL AND NATIONAL CODES.

To properly fit connections into panel, certain recommended modifications will need to be made. Refer to conduit fittings of choice instructions for proper cutouts to avoid damaging panel and maintain level of environmental rating.

3.1 Modifying Panel Enclosure

Any modifications to enclosure can derate panel. Ensure installed components meet or exceed panel type rating.

If panel contains fan, allow adequate space (min. 4" recommended) for airflow and clearance for panel modifications.

3.1.1 Input Power Outlet

For input power entry, the recommend location is at the top right face of enclosure. This will allow for easy access to line side of main circuit breaker.



24x24x10 Panel

3.1.2 Output Power and Sensors Outlet

For output power and connectors entry, the recommend location is at the bottom left face of enclosure (for 24x24x10 panel), or bottom center face (for 36x36x12 panel). This will allow for easy access to the customer hook-up terminals (Refer to AS BUILT drawing).

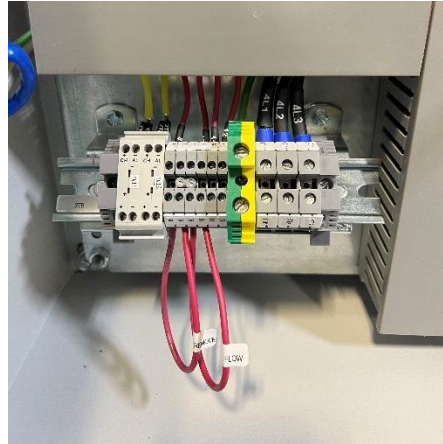

24x24x10 Panel

3.2 Mounting the Panel

Please note the unit is heavy and our recommendation is for a two-person lift. Follow provided instruction on mounting. The control panel has (4) wall mount legs, properly align and secure panel to wall. Refer to AS BUILT drawing for mounting dimensions. Panel must be mounted on wall in upright position.

Panel should be placed in a non-hazardous location and be provided adequate space for ventilation and safe electrical clearances.

3.3 Connecting Panel

All inputs to panel including load power, sensors, and external remote buttons are to be connected per AS BUILT drawing.

Please refer to drawing for recommended wire gauge and tightening torque specifications for field wiring. All wiring denoted as field wiring to be supplied by others and installed by a qualified electrical contractor per local and national codes.

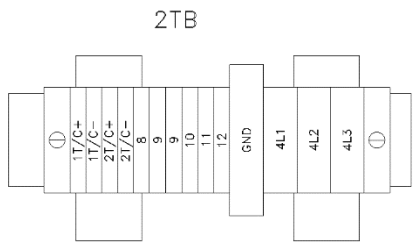

24x24x10 3-Ph Input Terminals

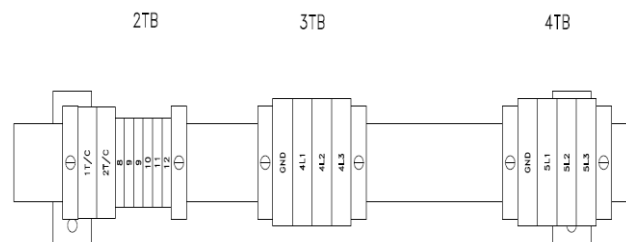

36x36x12 3-Ph Input Terminals

3.3.1 Load Power Connections

Terminal blocks for connecting load output will be determined by AS BUILT drawing.

Depending on input power phase, please refer to wiring schematic of panel for proper L1, L2, and L3 connections to breaker.

Main Ground Terminal will be to the left of circuit breaker.

3.3.2 Thermocouple Connections

There are 2 Type K thermocouple inputs on standard panel. The first is for high limit thermocouple (1/TC+, 1/TC-). The second is for process temperature thermocouple (2/TC+, 2/TC-). Connect sensor leads to proper terminal blocks.

Note: The red leg of the thermocouple is the (-) negative side.

3.3.3 Flow Switch Connection

For Flow Switch input, remove the jumper on terminal blocks (9[2]) & (10) and connect switch leads to terminal blocks. Switch should be normally open; for recommend switch specs, please contact Farnam. Switch to be rated 120VAC and 2A minimum.

3.3.4 Remote Connections

To install a Remote Stop, remove the jumper on terminal blocks (8) & (9[1]) and connect leads to terminal blocks.

Should be run to NC dry contacts (momentary recommended) and rated 120VAC and 2A minimum,

To install a Remote Start, connect leads to terminal blocks (11) & (12)

Should be run to NO dry contacts (momentary recommended) and rated 120VAC and 2A minimum,

3.3.5 (Optional) Eurotherm 3216 High Limit Controller

If panel is supplied with the optional Eurotherm High Limit Controller, please refer to section F on how to operate 3216 controller.

D. START-UP AND BASIC OPERATION

Before starting up panel, ensure panel is mounted securely, review inside of panel for debris, all electrical connections are properly tightened, and panel door is properly latched to avoid any damage to panel and prevent danger.

4.1 Process Flow Diagrams

Diagram for 24x24x10 panel

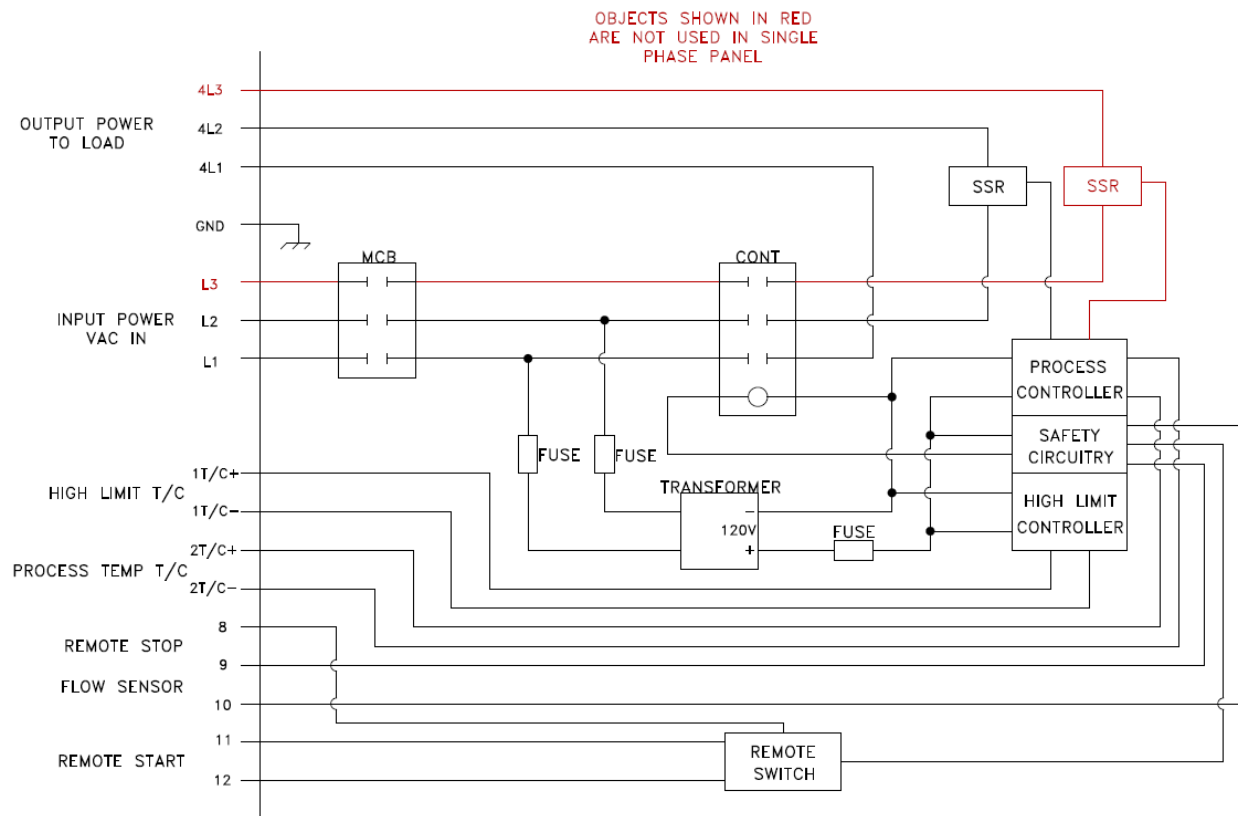
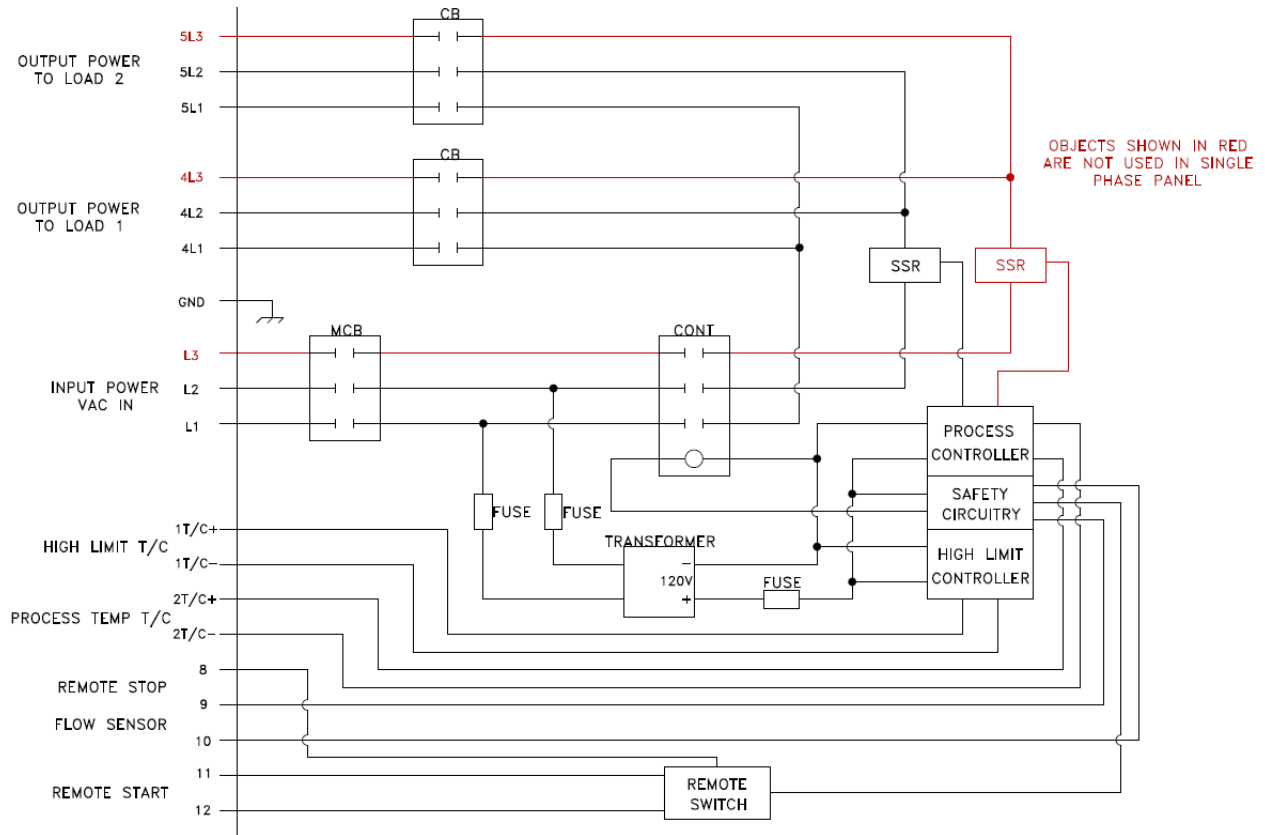
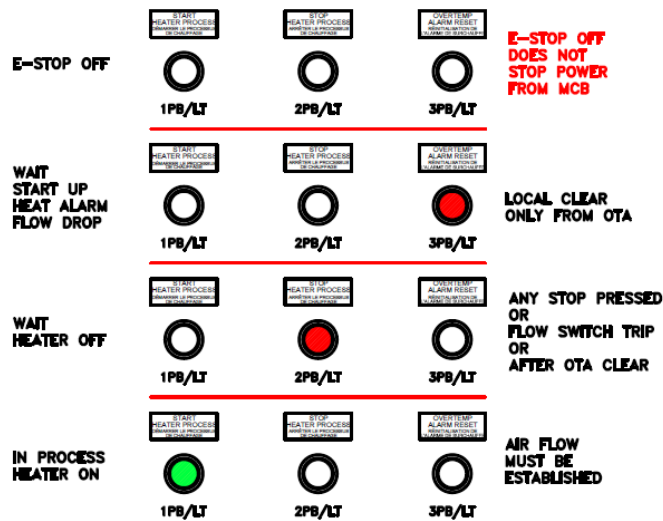

Diagram for 36x36x12 panel



Process for panel buttons



4.2 Powering Panel

To power on panel, first switch the main disconnect handle to the 'ON' position and ensure e-stop is in 'out' position. Once main disconnect is turned on, startup takes about 3-5 seconds. The process controller should switch on and after a few seconds display set point on bottom and current value on top.

Panel will come preprogrammed with certain parameters, and once auto tuned should be able to start use.

4.3 Operating Panel

The Eurotherm controller on the standard panel has four navigation buttons available. (Page, Scroll, Down, Up).

General Description of Front Panel Displays

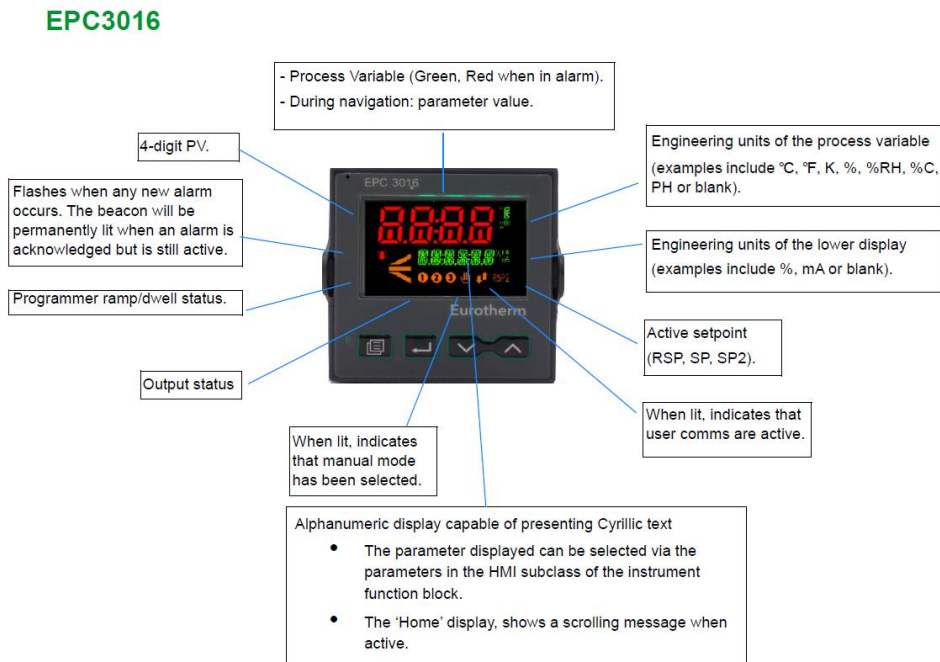

3.1 Process Controller Buttons

Button Operation

Raise

The raise button increments parameter values to limits.
Parameter enumerations, however, do wrap-around.

Lower

The lower button decrements parameter values to limits.
Parameter enumerations, however, do wrap-around.

Page

In Operator levels 1 or 2 the Page button will select between the Home display or the Programmer Edit and Run lists (if one of the programmer features is enabled).

In Levels 3 or Config the Page button will scroll through list headers (no auto-repeat).
If the Page button is pressed within a list, the display reverts to the top of the list. The top of the list shows the list header only with no initial parameters.

Page (held for >3 seconds)

The Goto parameter is selected directly. This operation can be performed from any display. If the Page is held for >3 seconds at power-up the Quick Start Mode is selected following the entry of a password.

Page+Raise

Scroll back the list headers (with auto-repeat).

Scroll

Select parameters in turn, returning to the first parameter in the list or to a list header if Level 3 or Configuration level is selected. If the button is held down the list will auto-repeat. In levels 1 and 2 this button also scrolls through promoted parameters when the HOME screen is selected.

Scroll+Raise

Scroll back through parameters from bottom to top (with auto-repeat).

Page+Scroll - all variants

Jump directly to the "HOME page". The current operating level remains unchanged.
If the HOME page is already selected, these buttons will perform the custom function as detailed in "Functionality of the F1 and F2 and Page + Scroll buttons" on page 196. The default is Alarm Acknowledge.

Raise+Lower (Run/Hold)

If a programmer option is enabled and a program is configured, a momentary press of these keys toggles between Run and Hold modes.

Raise+Lower (hold for >3 seconds - Mode)

If a programmer option is enabled and a configured program is running, holding these buttons will abort the program.

If the HOME page is selected and the Programmer is not running, holding these buttons will invoke the 'Mode' display where the Loop Mode parameter will allow selection of Auto or Manual mode.

4.3.2 Process Controller Navigation

Navigation

- a. Press and hold Page button to enter the different levels.
- b. Level 1 – Default level, to use scroll button to view information for different fields.
 - i. Set Point
 - ii. Threshold – high point
 1. **THLD** – High limit on temperature controller turns off output to heater.
 2. When the limit is reached the heater will turn off. To re-engage heater the Start button must be pressed again.
 - iii. **TUNE** – Autotune
 1. Note: Before using autotune feature allow heater to reach set point.
 2. To start autotune use scroll button to navigate through menu.
 3. When screen reads **TUNE** use the ^ to set to ON and press the home button.
 - iv. Level 2 – Password: 0002 (press page twice.)
 - v. **SP.HI** – Set absolute high for set point
 - vi. **SP.LO** – Set absolute low for set point
- c. Level 3 – Password 0003 (press and hold page button)
 - i. These are essentially the same as the Config level. However, the controller will stay active in this menu rather than powering down the output.
- d. Config – Password 0004 (press and hold till Level 3 visible, use up arrow for CONF)
 - i. After finished in Config menu return to Level 1 to reengage the controller.
 - ii. Units
 1. Default C to change to F
 - aa. CONF -> INST -> INFO -> T.UNIT -> dEGF
 - iii. Input Type
 1. Default type K thermocouple.
 - aa. Consult manual for other inputs.
 - iv. Communication pg. 149-154
 1. Ethernet
 2. IP
 3. Node
 4. Baud

4.3.3 Panel Buttons & Navigation

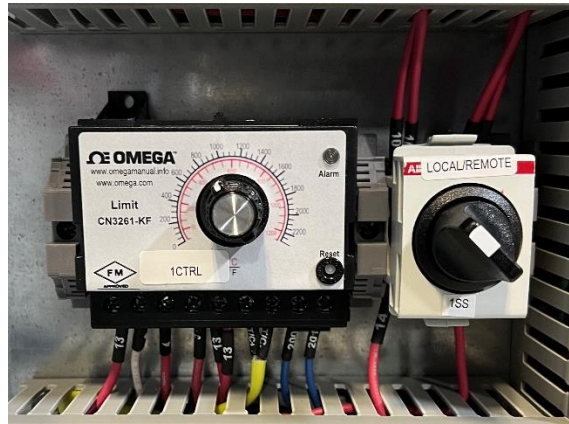

High Limit Controller and Remote/Local Switch

Setting High Limit Temperature:

High Limit temperature is set to 32°F by manufacture. This must be set to customer process and is recommended to be set at least 50°F above process temperature. To adjust this, the panel will need to be shut down and opened. Locate the high limit controller and adjust by turning the dial on the (1CTRL) left or right will lower or raise your high limit temperature.

If Panel has optional Eurotherm 3216 High Limit Controller, refer to section F of the manual for set up and use.

Setting Local/Remote Mode:

If using external controls to control panel, refer to section 3.3.4 to properly connect to panel. Once installed, shut down the panel and open door. Locate the local/remote switch (1SS) and turn to remote. While on remote, the buttons on the front of the panel will not operate.

E. EUROTHERM PROCESS CONTROLLER

The following are excerpts from Eurotherm's manual for basic programming features and operational functions of the Eurotherm controller.

For more information and adjustment details, please refer to the [Eurotherm Controller Instruction Manual](#).

5.1 Process

General

Controller Function	<ul style="list-style-type: none"> • Single loop panel mount PID controller range with autotune, ON/OFF, Valve Positioning (no slidewire required) • Zirconia probe atmosphere control • Single loop profile/program • AC mains voltage and 24Vdc options
Measurement Inputs	<ul style="list-style-type: none"> • 1 or 2 inputs. Accuracy $\pm 0.1\%$ reading (refer to detailed specification)
PID Control	<ul style="list-style-type: none"> • 2 PID sets are available as standard with 8 as an optional extension. Each PID set offers separate proportional band for heat and cool operation • Enhanced Autotuning control with cutback to minimize overshoot and oscillation. Fast reacting precision control to setpoint changes or after process disturbances • Enhanced valve positioning (unbounded) algorithm • Gain scheduling allows PID selection for a wide range of operating situations, including deviation from setpoint, absolute temperature, output level and others • AC supply voltage monitoring for feedforward. PV and SP feedforward functions
Setpoint Program/Profiler	<ul style="list-style-type: none"> • Options include 20 profiles of 8 steps (20x8), 10x24, 1x24 and 1x8 • Holdback ("guaranteed soak"), event outputs, time to target, ramp rate, dwell, step and call segment types • Communications compatible with Eurotherm 2400 programmer • Additional timer functions available
User function block wiring	<ul style="list-style-type: none"> • Optional Totalizer • Math • Logic and multiplexing • BCD conversion • Counter/Timer, and many other special function blocks available including 16 point linearization, zirconia and dual input switchover
Additional Functions	<ul style="list-style-type: none"> • Digital and analog retransmission functions • CT Input - Monitor partial load failure, load short and open circuit; Dual input functions including switchover, redundant sensor, average, min, max, zirconia • 6 Freely configurable alarms with manual, automatic, non-latching and event types plus alarm delay function and blocking • Alarms may be inhibited in standby • 5 Recipes with 40 freely selectable parameters switchable from front panel or digital input • Scrolling parameter help and user messages displayed on event • USB Backup lead and free configuration software
Backup and Configuration Tools	<ul style="list-style-type: none"> • Free Eurotherm iTools software for backup and configuration • USB Backup lead available for convenient desktop configuration and back up, (lead powers the controller independently) • iTools connects also using Ethernet Modbus TCP and serial Modbus RTU
OEM Security	<ul style="list-style-type: none"> • Helps protect instrument configurations from unauthorized viewing, cloning or backwards engineering

There are 5 levels of operation:-

1. **LEU1** - Level 1 has no password, the control is active and only the home list is accessible.
2. **LEU2** - Level 2. The control is active and an extended home list is accessible.
3. **LEU3** - Level 3. The control is active and the complete operator parameter set is shown and modifiable; the complete Configuration parameter set is shown, (read only); the user calibration (two point cal) facility is available.
4. **CONF** - Configuration level is used to setup the whole controller; the configuration parameters are accessible; the operator parameters are available, without the need to switch to operator mode. The instrument calibration parameters are also available in this mode. See "User Calibration" on page 369.





Levels 2, 3 and Configuration can be restricted by passwords.

Auto/Manual Mode

In Manual mode the value of the output is increased or decreased directly by the operator using the Up and Down buttons.



In Auto mode the process is adjusted automatically by the controller in response to differences between the setpoint and the actual measured value.

In Operator Level 1 the controller may be placed into manual operation as follows:

- By default in EPC3008 and EPC3004 controllers, Auto/Manual may be selected by the user by toggling the F1 button.
- By default in EPC3016 controller Auto/Manual may be selected by the user by pressing and holding the  and  buttons for longer than 3 seconds. This will show the A-M (Auto-manual select) parameter. Then press  or  to toggle between auto and manual.







Manual is indicated in the HMI by showing the 'Hand' symbol and the character 'M'.

The current level of the output demand is shown as a percentage. This may be increased or decreased by pressing the  or  buttons respectively.



Note: Alternative ways to select Auto/Manual may be configured and will be explained in subsequent chapters of this manual.

Level 1 Operator Parameters

A minimal list of parameters is available in Operator Level 1 which is designed for day to day use. Access to these parameters is not restricted by a password.

Press  to step through the list of available parameters. The mnemonic of the parameter is shown in the lower display. Alternatively, press and hold  then press  to scroll forward through parameters and  to scroll back.

Press  to return to the Home display.

The value of the parameter is shown in the upper display. If the value is read/write press  or  to adjust. If no key is pressed for 60 seconds the controller returns to the HOME display. The navigation is shown diagrammatically for the first two parameters in the example below:

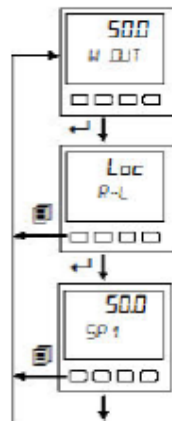

The parameters that appear depend upon the functions configured. The list can also be customized using iTools by adding or removing parameters. The table below shows an example of the list of parameters in Level 1. Parameters may be added to or deleted from this list, see "Parameter Promotion" on page 233.

Parameter Mnemonic	Scrolling name	Description	Further information
WOUT	WORKING OUTPUT	The output demand – 0% to 100% or –100% to +100%.	
R-L	REMOTE-LOCAL SELECT	Selects the Remote or Local setpoint source.	"Loop - Main Sub-list" on page 117.
SP1	SETPOINT 1	The value which the process is required to attain as set by setpoint 1.	
SP2	SETPOINT 2	The value which the process is required to attain as set by setpoint 2 if selected.	
AI1PV	PV	The current value of the process (read only) read by the primary input IP1.	
AI2PV	PV	The current value of the process (read only) read by the secondary input IP2.	If the secondary input is used.
LCI	CT LOAD CURRENT	The current being supplied to the heater as measured by the CT.	If the CT is being used.

Level 1 Programmer Display

By default, if the controller has the programmer installed, the status of a running program can be displayed.

Programmer List

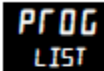
Press the page button , the display will show 

Repeatedly press  to read the currently running program.

Parameters displayed depend on the program and the type of segment configured but generally include the following:

Parameter Mnemonic	Scrolling name	Description
P.NUM	PROGRAM NUMBER	Alterable but does not affect the running program.
P.NAME	PROGRAM NAME	Read only. This parameter is available in firmware versions V3.01 and above.
P.CUR	CURRENT PROGRAM	Read only.
C.NAME	CURRENT PROG NAME	Read only. This parameter is available in firmware versions V3.01 and above.
P.MODE	PROGRAM MODE	Displays the current mode e.g. Run, Hold, Reset.
P.SP	PROGRAM SETPOINT	Read only.
P.TIML	PROGRAM TIME LEFT	Read only.
P.CYCL	PROGRAM CYCLES LEFT	Read only.
S.NUM	CURRENT SEGMENT NUMBER	Read only.
S.NAME	SEGMENT NAME	Read only. This parameter is available in firmware versions V3.01 and above.
S.TYPE	CURRENT SEGMENT TYPE	Read only.
S.TIML	SEGMENT TIME LEFT	Read only.
T.SP	TARGET SETPOINT	Read only.
R.RATE	RAMP RATE	Read only.
E.VT.X	EVENT X	Event off or on. Further events are shown if configured.
P.ADVN	PROGRAM ADVANCE	Read only.

By default the programmer parameters available in Level 1 are read only. It is possible, however, to provide programmer edit access to Level 1, see "Programmer List (PROG)" on page 135. If this has been done the lists of parameters is shown in section "Level 2 Programmer Display" on page 87.

Level 2 Operator Parameters

Parameters available in level 1 are also available in level 2, but level 2 includes additional parameters for commissioning purposes and for more detailed operation.

Press **◀** to step through the list of available parameters. The mnemonic of the parameter is shown in the lower display. Press **▶** to return to the previous parameter.

The value of the parameter is shown in the upper display. If the value is read/write press **▲** or **▼** to adjust. If no key is pressed for 60 seconds the controller returns to the top of the HOME list.

By default the following table lists all possible parameters available in both Levels 1 and 2. Parameters associated with a particular feature will only be shown if that feature is configured.

Parameter Mnemonic	Scrolling name	Description	Further information
WOUT	WORKING OUTPUT	The output current demand – 0% to 100% or -100% to +100%.	Level 1 & 2
R-L	LOOP REMOTE/LOCAL	Selects the Remote or Local setpoint source.	Level 1 & 2
SPHI	SETPOINT HIGH	Maximum value allowed for the local setpoints (SP1 and SP2).	
SPLO	SETPOINT LOW	Minimum value allowed for the local setpoints (SP1 and SP2).	
SP1	SETPOINT 1	The value which the process is required to attain as set by setpoint 1	Level 1 & 2
SP2	SETPOINT 2	The value which the process is required to attain as set by setpoint 2 if selected.	Level 1 & 2
SPUP	SETPOINT RATE UP	Limits the maximum rate at which the working setpoint can change in an increasing (upwards) direction. Setpoint rate limiting is often used to prevent rapid bumps in controller output that may damage equipment or product, or cause upset to downstream processes.	
SPDN	SETPOINT RATE DOWN	Limits the maximum rate at which the working setpoint can change in an increasing (downwards) direction.	
RI1PV	PV	The current value of the process (read only) read by the primary input IP1.	Level 1 & 2
RI2PV	PV	The current value of the process (read only) read by the secondary input IP2.	Level 1 & 2
TUNE	AUTOTUNE ENABLE	Starts an autotune.	"Autotuning" on page 309
P1H	CH1 PROPORTIONAL BAND	Channel 1 (heat) proportional band.	
P1C	CH2 PROPORTIONAL BAND	Channel 2 (cool) proportional band.	
TI	INTEGRAL TIME	Integral time.	
TD	DERIVATIVE TIME	Derivative time.	
C1H	CUTBACK HIGH THRESHOLD	High cutback.	
C1L	CUTBACK LOW THRESHOLD	Low cutback.	

Parameter Mnemonic	Scrolling name	Description	Further information
MR	CONTROL MANUAL RESET	If the integral parameter is turned off the controller is working in proportional only or proportional + derivative. This parameter allows the output to be adjusted manually to offset and difference between SP and PV.	
HYSH	CONTROL CH1 ON OFF HYSTERESIS	If channel 1 is configured for On/Off control this parameter allows a difference to be set between the output being on or off.	
HYSE	CONTROL CH2 ON OFF HYSTERESIS	If channel 2 is configured for On/Off control this parameter allows a difference to be set between the output being on or off.	
CD	CONTROL CH2 DEADBAND	The Ch1/Ch2 Deadband is a gap in percent between output 1 going off and output 2 coming on and vice versa. For on/off control this is taken as a percentage of the hysteresis.	
OUTH	OUTPUT HIGH LIMIT	To limit the maximum controller output.	
OUTL	OUTPUT LOW LIMIT	To limit the minimum controller output.	
LI	ET LOAD CURRENT	This is the sampled RMS current measured during the on time of the heater.	Level 1 & 2
LK	ET LEAK CURRENT	The RMS current measured flowing through the load during the off states of the controller.	
LISP	ET LOAD THRESHOLD	Sets a threshold to trigger an alarm if the load current is exceeded.	
LKSP	ET LEAK THRESHOLD	Sets a threshold to trigger an alarm if the leak current is exceeded.	
OCSP	ET OVERCURRENT THRESHOLD	Sets a threshold to trigger an over current alarm if the current measured exceeds a maximum limit set by the process.	
CSID	CUSTOMER ID	A user configurable non-volatile identification parameter.	
RECNO	DATASET TO LOAD	Selects which recipe dataset to load.	
STORE	DATASET TO SAVE	Selects which of the 5 recipe dataset in which to store the current active parameters.	

The home list can be customized by adding up to 60 parameters; iTools will be required to configure the promoted parameters, see "Parameter Promotion" on page 233.

Level 2 Programmer Display

If the controller has the programmer installed, by default, the programmer can be edited and operated from the HMI. A step by step guide to setting up a program is given in "To Setup a Program from the HMI" on page 268.

Programmer List

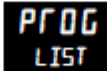
Press the page button , the display will show 

Repeatedly press  to read the currently running program. The program can be Run, Held or Reset from this list.

Parameters displayed are (but not limited to depending on the program):

Parameter Mnemonic	Scrolling name	Description
P.NUM	PROGRAM NUMBER	Alterable, but does not run a program.
P.NAME	PROGRAM NAME	Read only. This parameter has been added in firmware versions V3.01 and above.
P.CUR	CURRENT PROGRAM	Read only.
C.NAME	CURRENT PROG NAME	Read only. This parameter has been added in firmware versions V3.01 and above.
P.MODE	PROGRAM MODE	The programmer can be changed to Run, Hold, Reset,
P.SP	PROGRAM SETPOINT	Read only.
P.TIML	PROGRAM TIME LEFT	Read only.
P.CYCL	PROGRAM CYCLES LEFT	Read only.
S.NUM	CURRENT SEGMENT NUMBER	Read only.
S.NAME	SEGMENT NAME	Read only. This parameter has been added in firmware versions V3.01 and above.
S.TYPE	CURRENT SEGMENT TYPE	Read only.
S.TIML	SEGMENT TIME LEFT	Read only.
T.SP	TARGET SETPOINT	Read only.
R.RATE	RAMP RATE	Read only.
EVT.X	EVENT X	Event off or on. Further events are shown if configured.
P.ADVN	PROGRAM ADVANCE	Alterable YES/NO. Advances the program to the next segment.

Program Setup List

By default programs can be set up in Level 2.

Press the page button , the display will show

**P.SET
LIST**

Repeatedly press  to read the currently running program. Programs can be edited from this list.

Parameter Mnemonic	Scrolling name	Description
P.NUM	PROGRAM NUMBER	Alterable but does not run a program. If the program is running WORK is shown signifying the working program.
P.NAME	PROGRAM NAME	Read only. This parameter has been added in firmware versions V3.01 and above.
HOLD.STY	HOLDBACK STYLE	Alterable: PROG (holdback applies to the whole program). SEGm (holdback applies to each segment).
HOLD.TYP	HOLDBACK TYPE	Alterable: OFF, LOW, HIGH, bAND. For a full definition see "Holdback" on page 261.
RAMP.U	RAMP UNITS	Alterable: P.SEC (per second), P.min (per minute), P.HR (per hour).
DWEL.U	DWELL UNITS	Alterable: SECS, mins, HrS.
P.CYC	PROGRAM CYCLES	Alterable: The number of time a program repeats. CONT (continuous) or 1 to 9999. Default 1
P.END	PROGRAM END TYPE	Alterable: Behavior when the program ends dWEL (dwell at current setpoint). RSEt (reset). tRAK (track).
S.NUM	CURRENT SEGMENT NUMBER	Alterable:
S.NAME	SEGMENT NAME	Read only. This parameter has been added in firmware versions V3.01 and above.
S.TYP	SEGMENT TYPE	RAte, timE, dWEL, Step, CALL, ENd.
T.SP	TARGET SETPOINT	Alterable:
R.RATE	RAMP RATE	Alterable:
EV.OP	EVENT OUTPUT	Alterable:
DUR	DURATION	Alterable: Appears if the segment type is Dwell or Time.
R.TIME	TIME TO TARGET	Alterable: Appears if the segment type is Time.
C.PROG	CALL PROGRAM	Alterable: Appears if the segment type is Call.
C.CYC	CALL CYCLES	Alterable: Appears if the segment type is Call.

The above is a summary the parameters which are displayed (but not limited to) and depends on the program. A full description of the parameter meanings and how to set up programs is given in the following sections:

- Configuration chapter "Programmer List (PROG)" on page 135.
- Programmer chapter "Programmer" on page 257.

5.2 Auto Tuning

Before starting heating process, it is recommended to perform an auto tune initially to calibrate controller. For additional Autotune setting, refer to pg. 129 and 309 for more configurations.

Time	Description
A	<p>Autotune Begins</p> <p>Setting the <i>AutotuneEnable</i> parameter to On and the controller mode to Auto will cause the autotune to begin.</p> <p>Before starting an autotune, you should turn off the PID terms that you do not want to use. For example, setting TD to Off will disable derivative action and the autotuner will therefore tune for a PI controller. If you do not want any integral, set TI to Off and the autotuner will tune for a PD controller.</p> <p>If the cutback thresholds, CBH and CBL, are set to Auto then the autotuner will not attempt to tune them.</p> <p>An autotune may be triggered at any time, but it will not begin until the mode goes to Auto. If autotune is triggered but the controller is not in Auto mode the scrolling message <i>AUTOTUNE TRIGGERED BUT CANNOT RUN</i> is displayed. In this case put the controller into Auto mode, the message <i>AUTOTUNE ACTIVE</i> will be displayed and the controller will begin the autotune process. Similarly, autotune will abort if the mode is changed away from Auto at any time during the tune, including reasons such as sensor status is bad. In this case it will be necessary to start autotune again.</p> <p>Note that the PID tuning constants will be written to whichever gain set is active when tuning completes.</p>

5.3 Setting Common Parameters

NOTICE: ANY CHANGES TO CONTROLLER PARAMETERS AND SETTINGS SHOULD BE NOTED AND COULD ADVERSLY AFFECT CONTROL PANEL AND ANY DOWNSTREAM EQUIPMENT.

5.4 Communications

The main way to communicate with controller externally is via the Ethernet port located on the left side of the panel.

5.4.1 Ethernet communication

Refer to manual for information on all external ethernet communication capabilities.

The Controller should have 'AutoDiscovery' on by default. This allows auto detection of controller IP Address from iTools.

To turn this feature off, refer to pg.320 on Eurotherm controller user manual.

Setting IP Address:

For more information on setting IP address manual refer to pg. 322 on Eurotherm controller user manual.

To set up an IP address for Ethernet via the front panel

If DHCP is not used the IP address, Subnet mask and Default gateway addresses can be set up manually (the MAC addresses are set up in production and are read only).

The default IP address is 192.168.111.222 and the default subnet mask is 255.255.255.0.

8. From 13 above press the Scroll button to scroll through the Ethernet options. The Up and Down buttons allow the values to be altered.
9. Scroll through *IP A1*, *IP A2*, *IP A3*, and *IP A4* to set each part of the IP address, e.g. *IP.A1* = 192, *IP.A2* = 168, *IP.A3* = 111, *IP.A4* = 222.

The Subnet mask and Default gateway can be set in a similar way except the MAC address which is read only.

5.4.2 Collecting Data

- I. Collecting data
 - a. Enter iTools Engineering Studio
 - b. Open iTools OPC Scope Lite

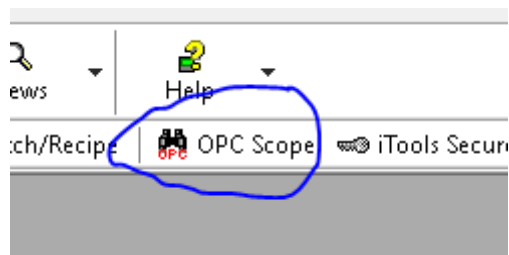

Inside iTools OPC Scope Lite.

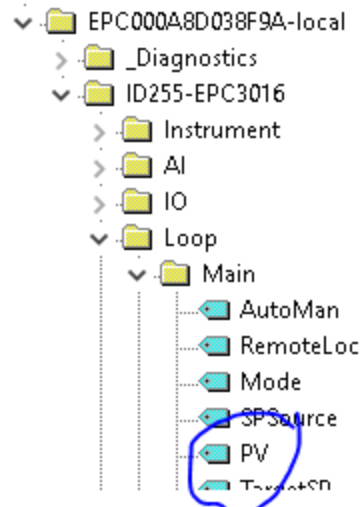

- c. Highlight PV from controller and add tag.
- d. Click Stat Data Logger
 - i. Will prompt user where to save.

5.4.3 Security

To Modify any security settings for controller, please refer to pg.19, 197, and 380 on Eurotherm controller user manual for information.

5.4.4 Links to Tutorials and Downloads

- e. Download software from the Eurotherm website.
 - i. [Eurotherm iTools Studio Download page.](#)
 - ii. Scroll down to Downloads and install Eurotherm iTools
- f. YouTube Link to communication set up:
 - i. https://www.youtube.com/watch?v=76PBqINx_fYr
 - ii. Video advises to set IP on computer. If you are dealing with one controller, we advise setting the IP on the controller instead.
- g. YouTube link to iTools user interface:
 - i. <https://www.youtube.com/watch?v=UPgakXKnZhE>
- h. Helpful pages in the Eurotherm Manual
 - i. Auto discovery pg300
 - ii. Ethernet pg. 71 and pg. 149

5.5 Alarms

What are Alarms?

For the purposes of this section alarms alert an operator when a pre-set threshold, determined by the user as applicable to his particular process, has been exceeded.

Unless they have been produced in a particular application, in EPC3000 series controllers there are no specific alarms. It is then necessary to wire alarm blocks using iTools (see "Graphical Wiring" on page 223).

They are indicated by flashing the red  beacon in the display. The green PV value will also turn red. If using the default user messages, a message will scroll indicating which alarm is active. The scrolling message may be customized using iTools (see "User Defined Messages" on page 235).

Alarms may also switch an output, usually a relay, to allow external devices to be activated when an alarm is active (see "Example 2: To Connect an Alarm to a Physical Output" on page 224).

Up to 6 process related alarms can be configured in all models.

Alarms can also be configured as 'Events'. If an alarm has been configured as an event, when it is active it will not be annunciated on the HMI or in the Instrument Alarm Status Word. Events may be used to operate an output.

Alarm Types

There are 4 distinct types of alarm; Absolute, Deviation, Rate of Change and Digital. These are split into the following 9 alarm types. The descriptions for these 9 alarm types are for the algorithms only, blocking and latching is applied separately, after the active/working state has been determined (See "Blocking" on page 252).



To Set Alarm Threshold

The levels at which absolute high and absolute low process alarms operate are adjusted by the **threshold** parameter, *THL*, found, by default, in Level 3 or Configuration Level.

It is also possible to 'promote' the threshold parameters to Levels 1 and 2 using iTools (see "Parameter Promotion" on page 233).

Select the appropriate operating level as described in "Operator Levels" on page 78.

Press  until the required alarm threshold is shown.

Press  or  to raise or lower the alarm threshold.

Alarm Indication

If any alarm is active and not acknowledged, the red  beacon will flash and the scrolling message will show the alarm number and its type, for example *ALARM 1* *RJ5H*. When any alarm is active and not acknowledged then the PV value on the top line will be red.



If more than one alarm is present each alarm message is scrolled in turn.

The alarm beacon will only turn off when all alarms are not active and have been acknowledged (if required).

Any output (usually a relay) attached to an alarm will operate and its corresponding beacon will be lit. To attach an output to an alarm see "Example 2: To Connect an Alarm to a Physical Output" on page 224.



It is normal to configure the relay to be de-energized in alarm so that an alarm can be indicated externally if power to the controller is removed.

To Acknowledge an Alarm











When on the Home page, by default press  and  together. This is true unless the functionality of these buttons has been changed using the PS.Fn parameter, see "Display Functionality Sub-List (Hml)" on page 195.

If the alarm is still active the  beacon will go steady but the scrolling message still shows.

There are other ways in which an alarm can be acknowledged:

1. In Level 3 or Configuration level select the list header which applies to the alarm then scroll to the parameter *ACK* - acknowledge. Then press  or  to *YES*. This reverts to *NO* as soon as the command is confirmed.
2. The ACK parameter can be 'promoted' to levels 1 or 2 using iTools in which case it appears in the chosen operator list. See "Parameter Promotion" on page 233.
3. F1 or F2 function keys can be configured to alarm acknowledge. See "Display Functionality Sub-List (Hml)" on page 195.
4. A digital input can be wired using iTools to alarm acknowledge. The procedure is the same as described in section "Example 2: To Connect an Alarm to a Physical Output" on page 224.
5. Use the "Global Ack" parameter in the instrument block to acknowledge all alarms.

The action which takes place depends on the latching type of the alarm configured. The following table shows a step by step action which takes place in the controller:

<i>NonE</i>	Non latching	<p>A non latching alarm will reset itself when the alarm condition is removed.</p> <p>If it is still present when acknowledged the  beacon illuminates constantly, the scrolling alarm messages remain and the output remains active.</p>												
<i>AutoE</i>	Automatic	<p>An auto latching alarm requires acknowledgement before it is reset. The acknowledgement can occur BEFORE the condition causing the alarm is removed.</p> <p>An example of the action for Alarm 1 attached to OP3 is described below:</p> <table border="1"> <tbody> <tr> <td>Alarm occurs</td> <td> will flash. The top row changes to red. A scrolling message will be displayed. Output 3 is active and beacon 3 is ON.</td> </tr> <tr> <td>Acknowledge (the alarm is still present)</td> <td> is constant. The scrolling message remains. Output 3 is active and Beacon 3 is ON.</td> </tr> <tr> <td>Alarm condition is removed.</td> <td>All conditions are reset.</td> </tr> <tr> <td>Alarm occurs</td> <td> will flash. The top row changes to red. A scrolling message will be displayed. Output 3 is active and beacon 3 is ON.</td> </tr> <tr> <td>Alarm 1 condition is removed</td> <td>No change from the above.</td> </tr> <tr> <td>Acknowledge (the alarm condition has been removed)</td> <td>The alarm indication and output are reset.</td> </tr> </tbody> </table>	Alarm occurs	 will flash. The top row changes to red. A scrolling message will be displayed. Output 3 is active and beacon 3 is ON.	Acknowledge (the alarm is still present)	 is constant. The scrolling message remains. Output 3 is active and Beacon 3 is ON.	Alarm condition is removed.	All conditions are reset.	Alarm occurs	 will flash. The top row changes to red. A scrolling message will be displayed. Output 3 is active and beacon 3 is ON.	Alarm 1 condition is removed	No change from the above.	Acknowledge (the alarm condition has been removed)	The alarm indication and output are reset.
Alarm occurs	 will flash. The top row changes to red. A scrolling message will be displayed. Output 3 is active and beacon 3 is ON.													
Acknowledge (the alarm is still present)	 is constant. The scrolling message remains. Output 3 is active and Beacon 3 is ON.													
Alarm condition is removed.	All conditions are reset.													
Alarm occurs	 will flash. The top row changes to red. A scrolling message will be displayed. Output 3 is active and beacon 3 is ON.													
Alarm 1 condition is removed	No change from the above.													
Acknowledge (the alarm condition has been removed)	The alarm indication and output are reset.													

mHn	Manual	The alarm continues to be active until both the alarm condition is removed AND the alarm is acknowledged. The acknowledgement can only occur AFTER the condition causing the alarm is removed. An example of the action for Alarm 1 attached to OP3 is described below:	
		Alarm occurs	 will flash. The top row changes to red. A scrolling message will be displayed. Output 3 is active and Beacon 3 is ON.
		Acknowledge (the alarm is still present)	No change from above.
		Alarm condition is removed	No change from above.
		Acknowledge (the alarm condition has been removed)	The alarm indication and output are reset.
Eunt	Event	No alarm indication and no latching. An example of the action for Alarm 1 attached to OP3 is described below:	
		Alarm occurs	Beacon 3 is ON. Output 3 is active.
		Acknowledge (the condition is still present)	No change from above.
		Alarm 1 condition is removed.	The output is reset.

By default alarms are configured as non-latching, de-energized during an alarm.

It is possible to mix alarms between any of the latching types listed above. Each alarm configured will behave independently.

A 'Global Alarm Acknowledge' parameter is available by default in Level 3 in the 'Instrument - Diagnostics' list. This may be wired in the same way as other parameters (for example, to a digital input) and is used to acknowledge all alarms.

Pressing the Reset Button in front of the control panel will acknowledge alarm, if the condition is no longer present.

5.5.1 Other Alarms

Refer to pg.141 and 245 on Eurotherm controller user guide for complete list and description of alarms.

F. EUROTHERM HIGH LIMIT CONTROLLER

This section refers only to panels that are equipped with a Eurotherm 3216 Controller for High Limit control.

6.1 High Limit Controller Interface



To Set the High Limit controller, Panel will need to be opened. Carefully adjust set point value to desired over temperature value.

Refer to the following excerpts from Eurotherm's manual for basics on interface and adjusting high limit set point and alarms.



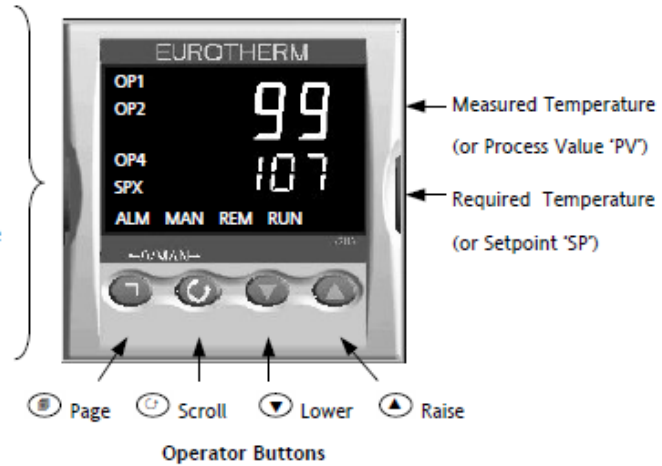

1.10.1 Operator Interface

Beacons:-

OP1 lit when output 1 is ON (normally heating)
 OP2 lit when output 2 is ON (normally cooling)
 OP4 lit when AA relay is ON (normally alarm)
 SPX Alternative setpoint in use (SP2)
 ALM Alarm active (Red)
 REM Remote setpoint or communications active
 RUN Timer running
 RUN (flashing) Timer in hold
 MAN Manual





Operator Buttons:-

-  From any display - press to return to the HOME display or select a page header
-  Press to select a new parameter from the page header. If held down it will continuously scroll through parameters.
-  Press to decrease an analogue value or to change the state of a digital (enumerated) value
-  Press to increase an analogue value or to change the state of a digital (enumerated) value

1.10.2 To Set The Required Temperature.



From the HOME display:-

- Press  to raise the setpoint
 Press  to lower the setpoint

The new setpoint is entered when the button is released and is indicated by a brief flash of the display.

1.10.3 Alarm Indication

If an alarm occurs the red ALM beacon will flash, a scrolling message will give the source of the alarm and the alarm (relay) output will operate.

Press  and  (ACK) together to acknowledge



If the alarm is still present the ALM beacon lights continuously.

The action which takes place depends on the type of alarm configured:-

Non latching	A non latching alarm will reset itself when the alarm condition is removed
Auto Latching	An auto latching alarm requires acknowledgement before it is reset. The acknowledgement can occur BEFORE the condition causing the alarm is removed.
Manual Latching	The alarm continues to be active until both the alarm condition is removed AND the alarm is acknowledged. The acknowledgement can only occur AFTER the condition causing the alarm is removed.

1.10.4 Auto/Manual/Off Mode

Auto mode is the normal closed loop operation where the output is adjusted automatically by the controller in response to a change in the input signal.









Manual mode means that the controller output power can be adjusted directly by the user. The input sensor is still connected and reading the PV but the control loop is open. The current level of the power output is adopted at the point of switch over from Auto to Manual. This is referred to as 'Bumpless Transfer'. The power output can be increased or decreased using the  or  buttons. Similarly, when Manual to Auto is selected the current manual output power is taken and the controller will then take over control. If the controller is powered down it will resume the same mode when powered up again.

Off mode can be selected (in Operator Level 2, see section 1.11) or when using a timer configured to turn the power output off at the end of a timed period.

 Manual operation must be used with care and the power level set must be chosen such that no damage can occur to the process. The use of a separate 'over-temperature' controller is recommended.

1.10.5 To Select Auto/Manual and Adjust the Output Power

Press  and  (Mode) together. This can only be accessed from the HOME display.

1. 'Auto' is shown in the upper display. The lower display will scroll the longer alternate description of this parameter, ie 'LOOP MODE - AUTO MANUAL OFF' 
2. Press  to select 'mAn'. This is shown in the upper display and the MAN beacon is lit. 
3. The controller will return to the HOME display. The upper display shows PV. The lower display shows demand power. At the point of changeover the manual demand power is the same as it was when in Auto (bumpless transfer auto to manual).
4. Press  or  to lower or raise the power. The output power is continuously updated when these buttons are pressed 
5. The loop can also be turned off (zero power output demand) by selecting 'OFF' in the upper display. Loop break is also turned off. The controller will return to the HOME display. The upper display shows the PV. The lower display shows OFF. The MAN beacon is lit in this mode.
6. To Return to Automatic operation, press  or  together. Then press  to select 'Auto'. At the point of changeover to automatic operation the power demand takes the current value and gradually changes to that required by the controller (bumpless transfer manual to auto)

6.2 Auto Tuning

7.2 Tuning

In tuning, you match the characteristics (PID parameters) of the controller to those of the process being controlled in order to obtain good control. Good control means:

Stable, 'straight-line' control of the PV at setpoint without fluctuation

No overshoot, or undershoot, of the PV setpoint

Quick response to deviations from the setpoint caused by external disturbances, thereby rapidly restoring the PV to the setpoint value.

Tuning involves calculating and setting the value of the parameters listed in the above table.

7.2.1 Automatic Tuning

This controller uses a one-shot tuner which automatically sets up the initial values of the parameters listed in the table on the previous page.

7.2.2 One-shot Tuning

The 'one-shot' tuner works by switching the output on and off to induce an oscillation in the measured value. From the amplitude and period of the oscillation, it calculates the tuning parameter values.

If the process cannot tolerate full heating or cooling being applied, then the levels can be restricted by setting the high power limit (' \bar{P}, H ') and low power limit (' \bar{P}, L '). However, the measured value *must* oscillate to some degree for the tuner to be able to calculate values.

A One-shot Tune can be performed at any time, but normally it is performed only once during the initial commissioning of the process. However, if the process under control subsequently becomes unstable (because its characteristics have changed), you can re-tune again for the new conditions.

It is best to start tuning with the process at ambient conditions and with the SP close to the normal operating level. This allows the tuner to calculate more accurately the low cutback and high cutback values which restrict the amount of overshoot, or undershoot.

Typical automatic tuning cycle

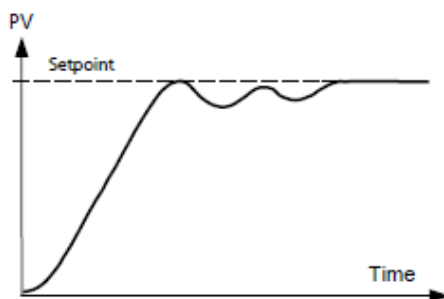

Autotune starts 1 minute after being turned on to determine steady state conditions.

Tuning normally takes place at a PV which has a value of setpoint x 0.7.

The power is automatically turned on and off to cause oscillations.

From the results the values shown in the table are calculated

7.2.3 Calculation of the cutback values

Low cutback and *High cutback* are values that restrict the amount of overshoot, or undershoot, that occurs during large step changes in PV (for example, under start-up conditions).

If either low cutback, or high cutback, is set to 'Auto' the values are fixed at three times the proportional band, and are not changed during automatic tuning.

To tune the cutback values, first set them to values other than Auto, then perform a tune as usual.

6.3 Alarm Options

Alarms

Alarms are used to alert an operator when a pre-set level has been exceeded. They are indicated by a scrolling message on the display and the red ALM beacon. They may also switch an output– usually a relay (see section 8.1.1) – to allow external devices to be operated when an alarm occurs. Alarms only operate if they have been ordered and configured.

Up to eight different alarms are available:-

- Alarm 1: configurable as full scale high or low, band or deviation high or low
- Alarm 2: configurable as full scale high or low, band or deviation high or low
- Alarm 3: configurable as full scale high or low, band or deviation high or low
- Alarm 4: configurable as full scale high or low, band or deviation high or low
- Sensor Fault alarm
- Loop Break alarm
- Current Transformer alarms – Leak, Load Fail, Overcurrent
- Remote Fail Alarm
- Power Fail Indication

Events are indication only but can operate an output. They can also be configured, using the editing tool (iTools), to provide scrolling text messages on the display.

For more details on changing controller parameters and features on the controller please refer to the **Eurotherm 3216 Controller Manual**.

NOTE: IT IS NOT RECOMMENDED TO ADJUST ANY PARAMETERS ON HIGH LIMIT CONTROLLER AS IT CAN ADVERSELY AFFECT CONTROL PANEL AND ANY DOWNSTREAM EQUIPMENT.

G. TROUBLESHOOTING

Troubleshooting control panel should be done by trained personnel with knowledge of the process of the control panel. If you do not feel comfortable, please contact Farnam. Refer to Section D to ensure correct process flow and operations are being followed.

7.1 Heater not heating up.

- a. Check front of panel.
 - i. If High limit controller is tripped the panel requires you to reengage by pressing the start button. The red button will be lit.
 - ii. If the display of the Eurotherm controller is red the High Limit temperature reached the programmed value in the controller and will need to be reengaged by pressing the start button.
 - iii. If neither situation is present, check the display of the Eurotherm controller. Press scroll to WOUT in menu. Is this climbing or at 100%? If it is the heater is not getting power from the panel.
 - iv. Shut down the panel and check the two items below.
 1. Fuses inside panel.
 2. All connections are secure.
 3. Heater resistance.
- b. Make sure you know if it is in Remote or Local mode.

7.2 Shuts down with the High Limit red light on.

- a. Ensure consistence/proper airflow.
- b. Check high limit controller.

7.3 Will not settle on set point.

- a. Ensure consistent/proper air flow.
- b. Auto tune

7.4 Error/notification messages on controller.

- a. Notification Messages pg. 346 from the Eurotherm Controller manual.

7.5 Panel buttons not working.

- a. Check that the local/remote switch is set to the correct position.
- b. If using remote buttons, ensure connections are properly secured.

7.6 Panel controls & display not powering on.

- a. Ensure all power connections are secure and panel is receiving power.
- b. Check damages to main breaker handle, and that it is in the on position.
- c. E-stop should not be engaged.
- d. Check for blown fuses.

7.7 Replacing blown fuses.

If fuses need to be replaced, refer to panel drawing or chart located on inside of panel door. DO NOT use any other type of fuses and ensure they are correctly rated. If fuse holders appear damaged, please contact Farnam Custom Products.



24x24x10 3-Ph Panel

Type and amount of fuses may vary depending on panel. To replace, open the fuse holder by pulling down on the tabs. Carefully pull fuse out and discard properly, fuse may be hot so handle with care.

Place new fuse inside holder and ensure it is securely shut. To test fuses, power on panel and you should see green indicator light showing that fuses are powered.

Z. APPENDIX

Links:

<https://www.eurotherm.com/us/eurotherm-downloads/>